

■  
Nero  
Black varnished

□  
Zincato tropical  
Zinc-coated

Conf.  
Pz.

Fermapersiana M1 con vite e tassello M1 shutter stop	COD. 85 NO 712 TA	COD. 85 ZT 712 TA	25
---	-------------------	-------------------	----

Fermapersiana M2 con fermo,vite e tassello M2 shutter stop	COD. 85 NO 722 TA	COD. 85 ZT 722 TA	25
---	-------------------	-------------------	----

Materiale: ferro  
Material: iron

**MI**

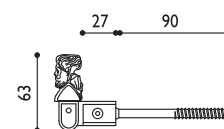

**M2**

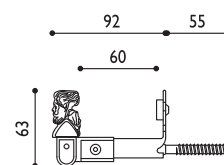

FERMAPERSIANE



Nero  
Black varnished



Zincato tropical  
Zinc-coated

Conf.  
Pz.

Fermapersiana registrabile M3 con vite e tassello M3 shutter stop	COD. 85 NO 742 TA	COD. 85 ZT 742 TA	40
Fermapersiana registrabile M3 con vite mm 105 per cappotto M3 shutter stop	COD. 85 NO 742 VL	COD. 85 ZT 742 VL	40
Fermapersiana registrabile M3 doppio con vite e tassello M3 shutter stop	COD. 85 NO 744 TA	COD. 85 ZT 744 TA	25
Fermapersiana registrabile M3 doppio con vite mm 105 per cappotto M3 shutter stop	COD. 85 NO 744 VL	COD. 85 ZT 744 VL	25
Fermapersiana registrabile M4 con vite e tassello M4 shutter stop	COD. 85 NO 732 TA	COD. 85 ZT 732 TA	50
Fermapersiana registrabile M4 doppio con vite e tassello M4 shutter stop	COD. 85 NO 734 TA	COD. 85 ZT 734 TA	25

Materiale: ferro

Material: iron

## M3



## M4



FERMAPERSIANE

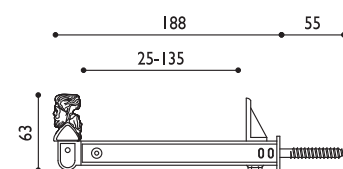
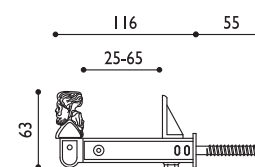
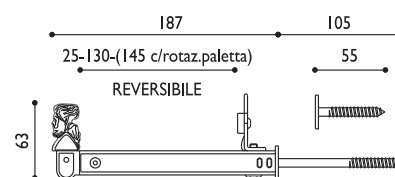
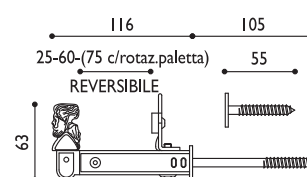

■  
Nero  
Black varnished

□  
Zincato tropical  
Zinc-coated

Conf.  
Pz.

Fermapersiana registrabile C1 con vite e tassello C1 shutter stop	COD. 86 NO 772 TA	COD. 86 ZT 772 TA	50
Fermapersiana registrabile C1 con vite mm 105 per cappotto C1 shutter stop	COD. 86 NO 772 VL	COD. 86 ZT 772 VL	50
Fermapersiana registrabile C2 con vite e tassello C2 shutter stop	COD. 86 NO 732 TA	COD. 86 ZT 732 TA	50
Fermapersiana registrabile C2 con vite mm 105 per cappotto C2 shutter stop	COD. 86 NO 732 VL	COD. 86 ZT 732 VL	50
Fermapersiana registrabile C2 doppio con vite e tassello C2 shutter stop	COD. 86 NO 734 TA	COD. 86 ZT 734 TA	25
Fermapersiana registrabile C2 doppio con vite mm 105 per cappotto C2 shutter stop	COD. 86 NO 734 VL	COD. 86 ZT 734 VL	25

Materiale: ferro  
Material: iron

**C1**



**C2**



FERMAPERSIANE

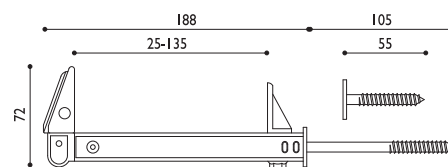
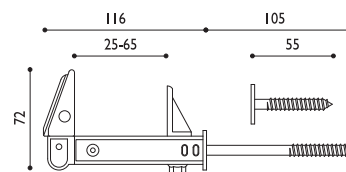
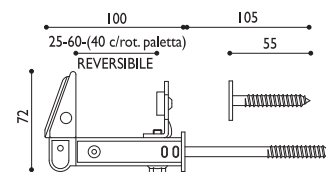



Zincato +  
Nero  
Zinc +  
Black varnished



Nero  
Black varnished



Zincato tropical  
Zinc-coated

Conf.  
Pz.

Fermapersiana 2 regolazioni C3 con vite e tassello C3 shutter stop	COD. 86 NO 752 TA	COD. 86 ZT 752 TA	40
Fermapersiana 2 regolazioni C3 con vite mm 105 per cappotto C3 shutter stop	COD. 86 NO 752 VL	COD. 86 ZT 752 VL	40
Fermapersiana 2 regolazioni C3 doppio con vite e tassello C3 shutter stop	COD. 86 NO 754 TA	COD. 86 ZT 754 TA	25
Fermapersiana 2 regolazioni C3 doppio con vite mm 105 per cappotto C3 shutter stop	COD. 86 NO 754 VL	COD. 86 ZT 754 VL	25
Fermapersiana registrabile a pendolo PI con vite e tassello PI shutter stop	COD. 87 NO 732 TA	COD. 87 ZT 732 TA	40
Fermapersiana registrabile a pendolo PI con vite mm 105 per cappotto PI shutter stop	COD. 87 NO 732 VL	COD. 87 ZT 732 VL	40
Fermapersiana registrabile a pendolo PI doppio con vite e tassello PI shutter stop	COD. 87 NO 734 TA	COD. 87 ZT 734 TA	25
Fermapersiana registrabile a pendolo PI doppio con vite mm 105 per cappotto PI shutter stop	COD. 87 NO 734 VL	COD. 87 ZT 734 VL	25

Materiale: ferro

Material: iron

**C3**



**PI**



FERMAPERSIANE

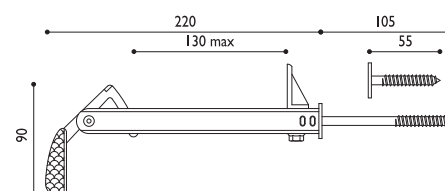
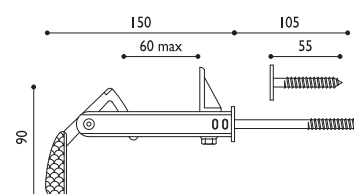
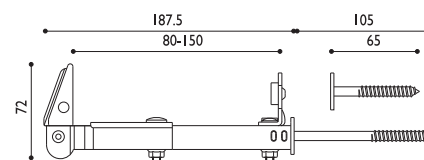
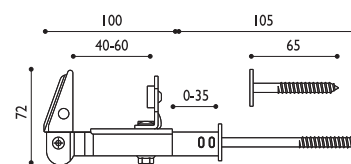

127



Plastica nera  
Black plastic



Plastica oro  
Gold plastic



Nero  
Black varnished



Zincato tropical  
Zinc-coated

Conf.  
Pz.

Fermapersiana automatica 4 posizioni con vite e tassello COD. 89 PN 799 TA 50  
Automatic shutter stop

Fermapersiana per balcone COD. 89 NO 796 COD. 89 ZT 796 25  
Shutter stop

Distanziale mm 6 COD. 89 PN 797 COD. 89 PT 797 100

Spacer mm 6

Materiale: plastica nera  
Material: black plastic



Materiale: zircal  
Material: zircal



DISTANZIALE

FERMAPERSIANE

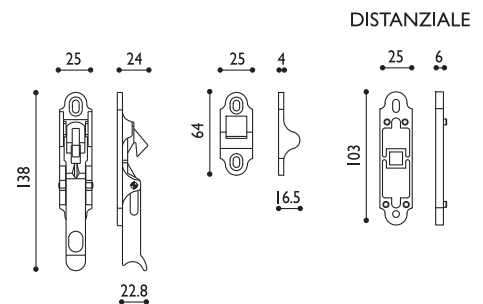
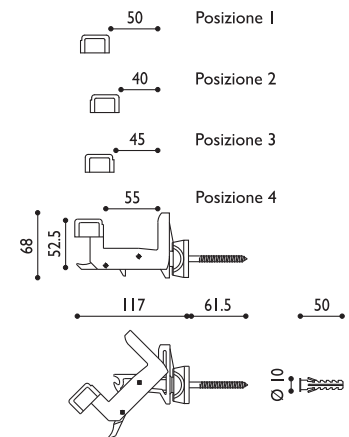



ABS / Ferro nero  
Plastic / Black iron



ABS / Ferro zincato tropical  
Gold plastic / Zinc iron

Conf.  
Pz.

Fermapersiana universale Dx-Sx con molla per singola L = mm 120 Shutter stop with spring	COD. 89 PN 791	COD. 89 PT 791	12
Fermapersiana universale Dx-Sx con molla per doppia L = mm 180 Shutter stop with spring	COD. 89 PN 792	COD. 89 PT 792	12

**Materiale:** ABS/Ferro

**Material:** Plastic/iron



FERMAPERSIANA UNIVERSALE

